

we
are
arco

product
Kami

we
make
tables

designer
**Joost
van der Vecht**

arco

Year
2020

Assembly
instructions

Please follow step 1 - 11

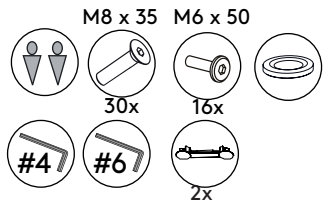

- ② With more than two table-tops, continue at this step.
If you have a table of only two table-tops, skip to step 5

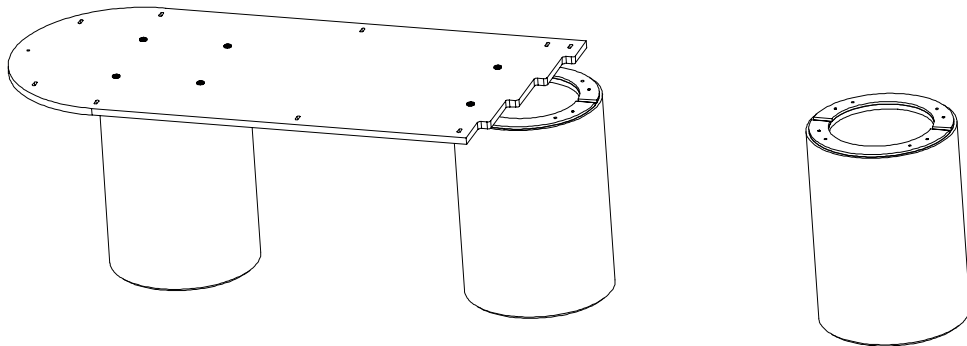

①

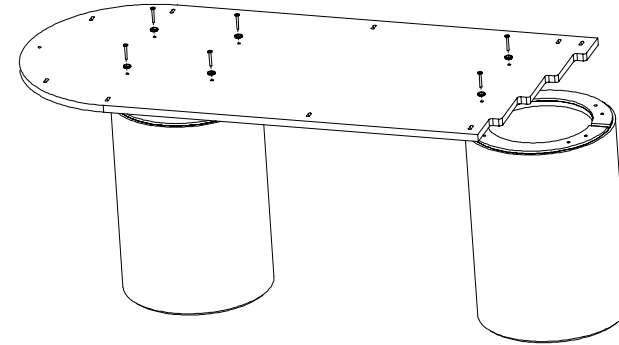
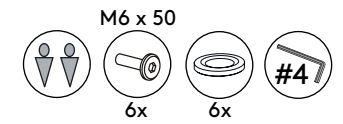



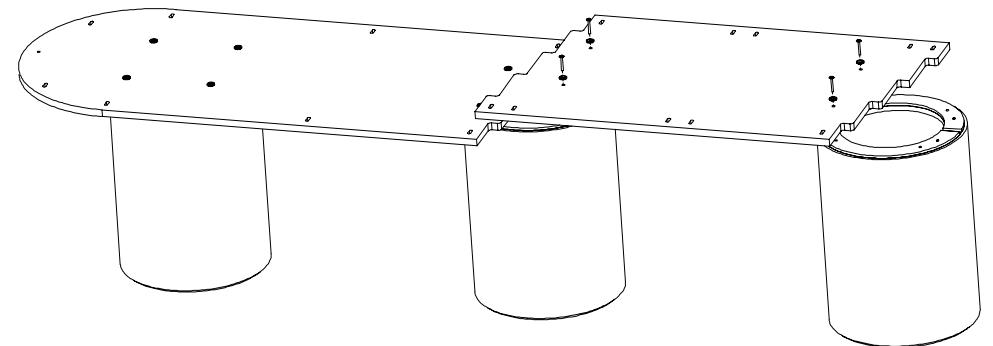
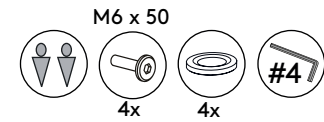

③

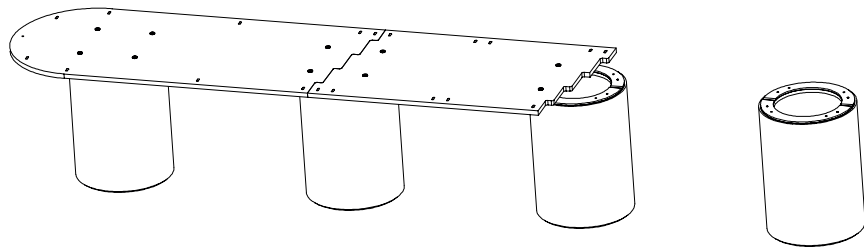

4



5

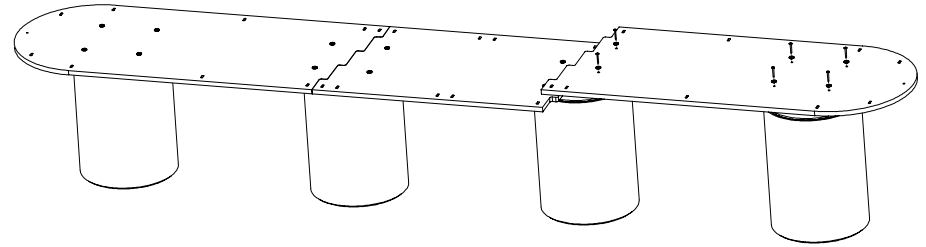

M6 x 50
  6x  6x  #4

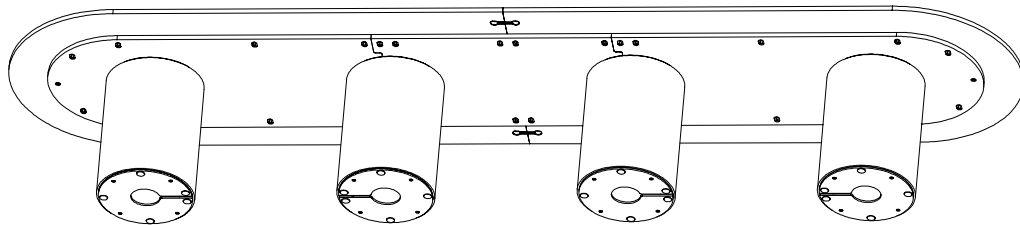

6



7

  2x

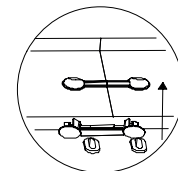
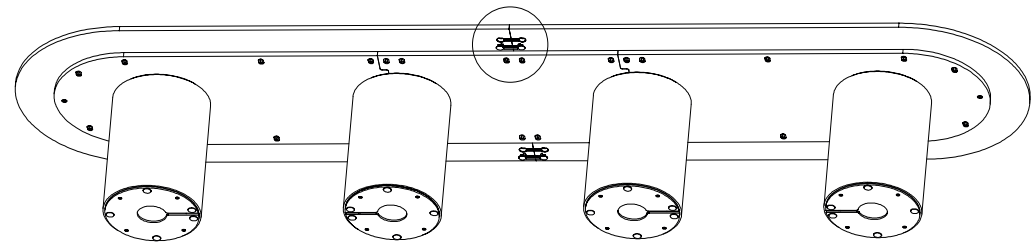

8

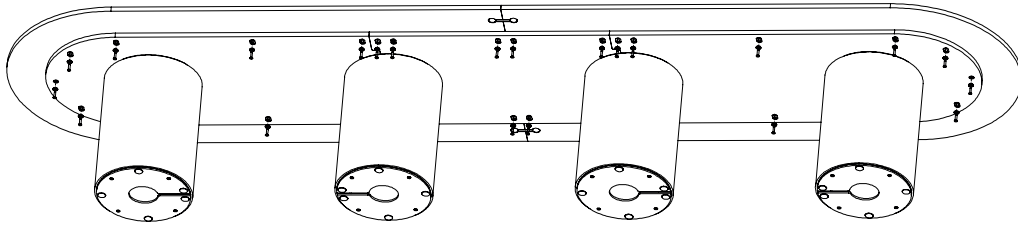
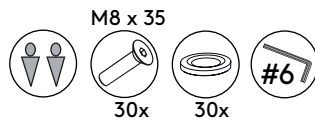

9

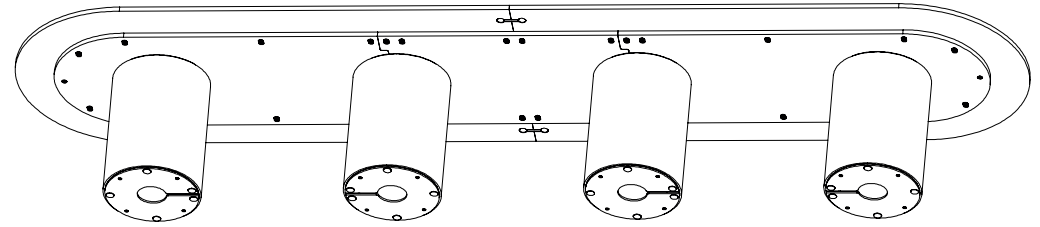

10

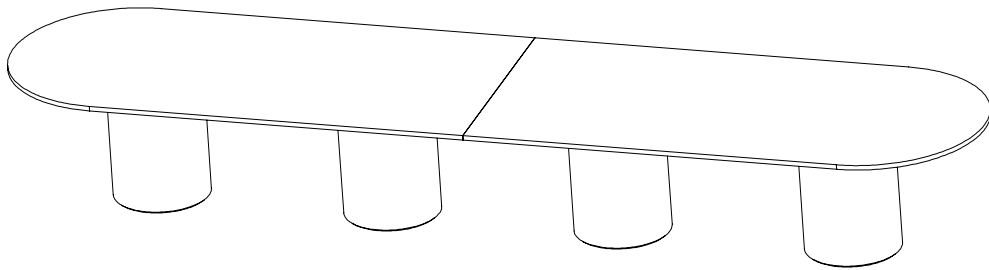

11



Instructions to correct the evenness of the table-top.
 Can be corrected on two sides by means of tightening the sludge.
 As a result of tightening this sludge, the table-top will "swell" a little.

